

New!

# Model 78862

## 4-Channel 200 MHz A/D with Multiband DDCs and Kintex UltraScale FPGA - PCIe



### General Information

Model 78862 is a member of the Jade™ family of high-performance PCIe boards. The Jade architecture embodies a new streamlined approach to FPGA-based boards, simplifying the design to reduce power and cost, while still providing some of the highest-performance FPGA resources available today. Designed to work with Pentek's new Navigator™ Design Suite of tools, the combination of Jade and Navigator offers users an efficient path to developing and deploying FPGA-based data acquisition and processing.

The 78862 is a multichannel, high-speed data converter with programmable DDCs (digital downconverters). It is suitable for connection to HF or IF ports of a communications or radar system. Its built-in data capture feature offers an ideal turnkey solution as well as a platform for developing and deploying custom FPGA-processing IP.

It includes four A/Ds, a complete multiboard clock and sync section and a large DDR4 memory. In addition to supporting PCI Express Gen. 3 as a native interface, the Model 78862 includes optional high-bandwidth connections to the Kintex UltraScale FPGA for custom digital I/O.

### The Jade Architecture

Evolved from the proven designs of the Pentek Cobalt and Onyx families, Jade raises the processing performance with the new flagship family of Kintex UltraScale FPGAs from Xilinx. As the central feature of the board architecture, the FPGA has access to all data and control paths, enabling factory-installed functions including data multiplexing,

channel selection, data packing, gating, triggering and memory control. The Jade architecture organizes the FPGA as a container for data-processing applications where each function exists as an intellectual property (IP) module.

Each member of the Jade family is delivered with factory-installed applications ideally matched to the board's analog interfaces. The 78862 factory-installed functions include four A/D acquisition IP modules for simplifying data capture and transfer.

Each of the four acquisition IP modules contains a powerful, programmable DDC IP core; an IP module for DDR4 SDRAM memory; a controller for all data clocking and synchronization functions; a test signal generator; and a PCIe interface. These complete the factory-installed functions and enable the 78862 to operate as a complete turnkey solution for many applications, thereby saving the cost and time of custom IP development.

### Extendable IP Design

For applications that require specialized functions, users can install their own custom IP for data processing. The Pentek Navigator FPGA Design Kits include the board's entire FPGA design as a block diagram that can be edited in Xilinx's Vivado tool suite. In addition to the block diagrams, all source code and complete IP core documentation is included. Developers can integrate their own IP along with the Pentek factory-installed functions or use the Navigator kit to completely replace the Pentek IP with their own. ▶

### Features

- Complete radar and software radio interface solution
- Supports Xilinx Kintex UltraScale FPGAs
- Four 200 MHz 16-bit A/Ds
- Four wideband DDCs and 32 multiband DDCs (digital downconverters)
- 5 GB of DDR4 SDRAM
- Sample clock synchronization to an external system reference
- LVPECL clock/sync bus for multiboard synchronization
- PCI Express (Gen. 1, 2 & 3) interface up to x8
- Optional LVDS and gigabit serial connections to the FPGA for custom I/O
- Ruggedized version available

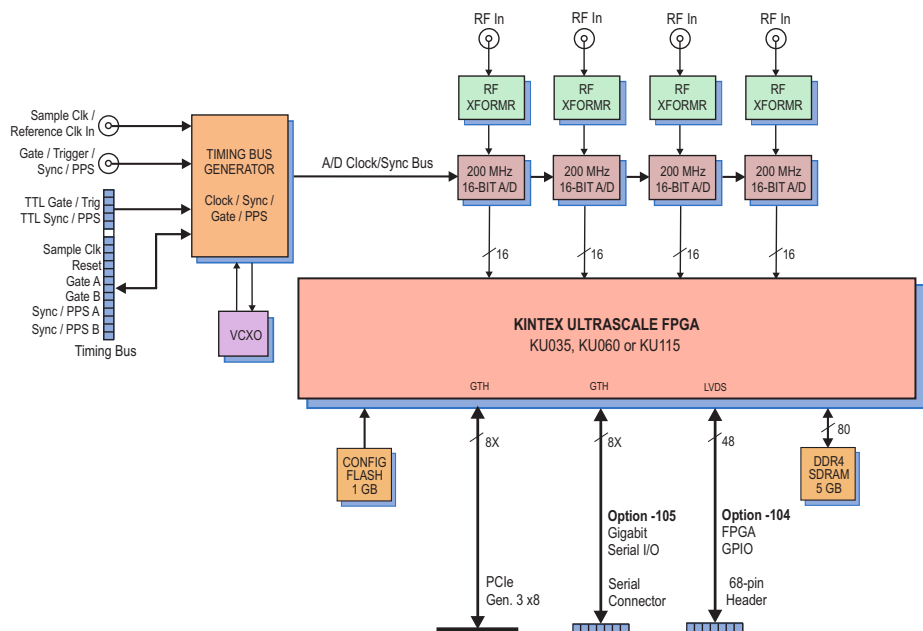

**A/D Acquisition IP Modules**

The 78862 features four A/D Acquisition IP Modules for easily capturing and moving data. Each IP module can receive data from any of the four A/Ds or a test signal generator

Each IP module has an associated DMA engine for easily moving A/D data through the PCIe interface. These powerful linked-list DMA engines are capable of a unique Acquisition Gate Driven mode. In this mode, the length of a transfer performed by a link definition need not be known prior to data acquisition; rather, it is governed by the length of the acquisition gate. This is extremely useful in applications where an external gate drives acquisition and the exact length of that gate is not known or is likely to vary.

For each transfer, the DMA engine can automatically construct metadata packets containing A/D channel ID, a sample-accurate time stamp and data length information. These actions simplify the host processor's job of identifying and executing on the data.

**DDC IP Cores**

Within each A/D Acquisition IP Module are two powerful DDC IP cores. A single-channel wideband DDC core and an eight-channel multiband DDC core. Each Acquisition Module can choose between the two cores allowing for a very flexible downconversion solution.

Each wideband DDC has an independent 32-bit tuning frequency setting that ranges from DC to  $f_s$ , where  $f_s$  is the A/D sampling frequency. Each DDC can have its own unique decimation setting. Decimations can be programmed from 2 to 32.

Each multiband DDC has eight DDC channels each with its own independent 32-bit tuning frequency setting that ranges from DC to  $f_s$  where  $f_s$  is the A/D sampling frequency. Decimations can be programmed from 2 to 1024.

The decimating filters for all DDCs accept a unique set of user-supplied 24-bit coefficients. The 80% default filters deliver an output bandwidth of  $0.8 \cdot f_s / N$ , where N is the decimation setting. The rejection of adjacent-band components within the 80% output bandwidth is better than 100 dB. Each DDC delivers a complex output stream consisting of 24-bit I + 24-bit Q or 16-bit I + 16-bit Q samples at a rate of  $f_s / N$ .

**Xilinx Kintex UltraScale FPGA**

The Kintex UltraScale FPGA site can be populated with a range of FPGAs to match the specific requirements of the processing task, spanning the KU035 through KU115. The KU115 features 5520 DSP48E2 slices and is ideal for modulation/demodulation, encoding/decoding, encryption/decryption, and channelization of the signals between transmission and reception. For applications not requiring large DSP resources or logic, a lower-cost FPGA can be installed.

Option -104 installs 24 pairs of LVDS connections from the FPGA to a 68-pin header for custom I/O.

Option -105 provides one 8X gigabit link between the FPGA and a serial connector to support serial protocols.

**A/D Converter Stage**

The front end accepts four analog HF or IF inputs on front panel SSMC connectors with transformer coupling into four TI ADS5485 200 MHz, 16-bit A/D converters. The digital outputs are delivered into the Kintex

UltraScale FPGA for signal-processing or routing to other board resources.

**Clocking and Synchronization**

An internal timing bus provides all timing and synchronization required by the A/D converters. It includes a clock, two sync and two gate or trigger signals. An on-board clock generator receives an external sample clock from the front panel SSMC connector. This clock can be used directly by the A/D or divided by a built-in clock synthesizer circuit.

In an alternate mode, the sample clock can be sourced from an on-board programmable voltage-controlled crystal oscillator. In this mode, the front panel SSMC connector can be used to provide a 10 MHz reference clock for synchronizing the internal oscillator.

A front panel 26-pin LVPECL Clock/Sync connector allows multiple boards to be synchronized. In the slave mode, it accepts LVPECL inputs that drive the clock, sync and gate signals. In the master mode, the LVPECL bus can drive the timing signals for synchronizing multiple boards.

Multiple boards can be driven from the LVPECL bus master, supporting synchronous sampling and sync functions across all connected boards.

**Memory Resources**

The 78862 architecture supports a 5 GB bank of DDR4 SDRAM memory. User-installed IP along with the Pentek-supplied DDR4 controller core within the FPGA can take advantage of the memory for custom applications.

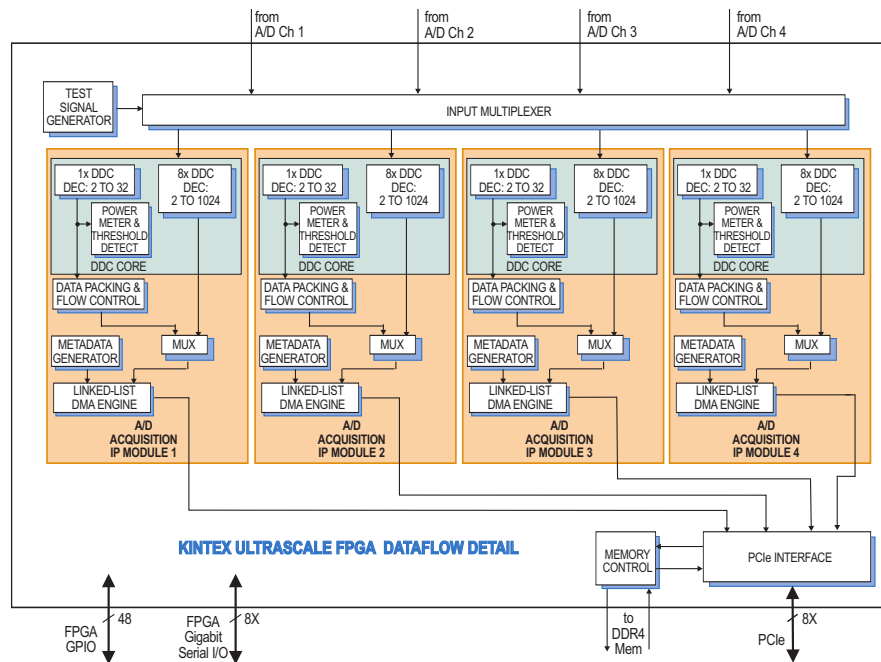

## SPARK Development Systems

The SPARK Development Systems are fully-integrated platforms for Pentek Cobalt, Onyx, Jade and Flexor boards. Available in a PCIe rackmount (Model 8266), a 3U VPX chassis (Model 8267) or a 6U VPX chassis (Model 8264), they were created to save engineers and system integrators the time and expense associated with building and testing a development system. Each SPARK system is delivered with the Pentek board(s) and required software installed and equipped with sufficient cooling and power to ensure optimum performance.



## Ordering Information

Model	Description
78862	4-Channel 200 MHz A/D with multiband DDCs and Kintex UltraScale FPGA - x8 PCIe

### Options:

- 084	XCKU060-2 FPGA
- 087	XCKU115-2 FPGA
- 104	LVDS FPGA I/O through 68-pin ribbon cable connector
- 105	Gigabit serial FPGA I/O through serial connector
- 702	Air cooled, Level L2

## ► PCI Express Interface

The Model 78862 includes an industry-standard interface fully compliant with PCI Express Gen. 1, 2 and 3 bus specifications. Supporting PCIe links up to x8, the interface includes multiple DMA controllers for efficient transfers to and from the board.

## Specifications

### Front Panel Analog Signal Inputs

**Input Type:** Transformer-coupled, front panel female SSMC connectors  
**Transformer Type:** Coil Craft WBC4-6TLB  
**Full Scale Input:** +8 dBm into 50 ohms  
**3 dB Passband:** 300 kHz to 700 MHz

### A/D Converters

**Type:** Texas Instruments ADS5485  
**Sampling Rate:** 10 MHz to 200 MHz  
**Resolution:** 16 bits

### Wideband Digital Downconverters

**Quantity:** Four channels  
**Decimation Range:** 2x to 32x  
**LO Tuning Freq. Resolution:** 32 bits, 0 to  $f_s$   
**LO SFDR:** >120 dB  
**Phase Offset Resolution:** 32 bits, 0 to 360 degrees

**FIR Filter:** 24-bit coefficients, 24-bit output, user-programmable coefficients  
**Default Filter Set:** 80% bandwidth, <0.3 dB passband ripple, >100 dB stopband attenuation

### Multiband Digital Downconverters

**Quantity:** Four banks, 8 channels per bank  
**Decimation Range:** 2x to 1024x  
**LO Tuning Freq. Resolution:** 32 bits, 0 to  $f_s$ , independent tuning for each channel  
**LO SFDR:** >120 dB

**Phase Offset Resolution:** 32 bits, 0 to 360 degrees  
**FIR Filter:** 24-bit coefficients, 24-bit output, user-programmable coefficients  
**Default Filter Set:** 80% bandwidth, <0.3 dB passband ripple, >100 dB stopband attenuation

**Sample Clock Sources:** On-board clock synthesizer

## Clock Synthesizer

**Clock Source:** Selectable from on-board programmable VCXO (10 to 810 MHz), front panel external clock or LVPECL timing bus

**Synchronization:** VCXO can be locked to an external 4 to 180 MHz PLL system reference, typically 10 MHz

**Clock Dividers:** External clock or VCXO can be divided by 1, 2, 4, 8, or 16 for the A/D clock

## External Clock

**Type:** Front panel female SSMC connector, sine wave, 0 to +10 dBm, AC-coupled, 50 ohms, accepts 10 to 800 MHz divider input clock or PLL system reference

**Timing Bus:** 26-pin connector LVPECL bus includes, clock/sync/gate/PPS inputs and outputs; TTL signal for gate/trigger and sync/PPS inputs

## External Trigger Input

**Type:** Front panel female SSMC connector, LVTTTL

**Function:** Programmable functions include: trigger, gate, sync and PPS

## Field Programmable Gate Array

**Standard:** Xilinx Kintex UltraScale XCKU035-2

**Option -084:** Xilinx Kintex UltraScale XCKU060-2

**Option -087:** Xilinx Kintex UltraScale XCKU115-2

## Custom I/O

**Option -104:** installs 24 pairs of LVDS connections from the FPGA to a 68-pin header for custom I/O.

**Option -105:** provides one 8X gigabit link between the FPGA and a serial connector to support serial protocols.

## Memory

**Type:** DDR4 SDRAM

**Size:** 5 GB

**Speed:** 1200 MHz (2400 MHz DDR)

## PCI-Express Interface

**PCI Express Bus:** Gen. 1, 2 or 3: x4 or x8

## Environmental

**Standard: L0 (air cooled)**

**Operating Temp:** 0° to 50° C

**Storage Temp:** -20° to 90° C

**Relative Humidity:** 0 to 95%, non-condensing

**Option -702: L2 (air cooled)**

**Operating Temp:** -20° to 65° C

**Storage Temp:** -40° to 100° C

**Relative Humidity:** 0 to 95%, non-condensing

**Size:** PCIe card, 4.380 in x 7.130 in (111.25 mm x 181.10 mm) ►

A/D Performance

Spurious Free Dynamic Range

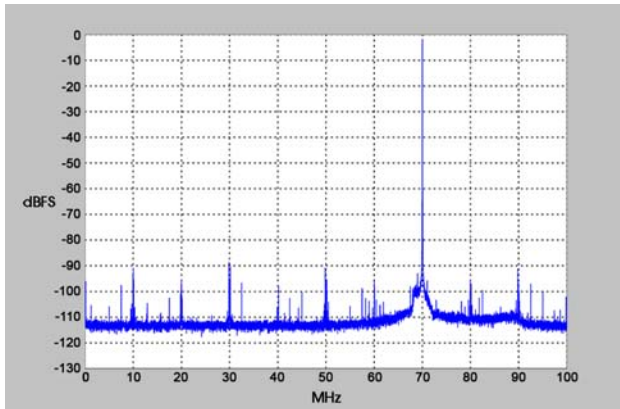

$f_{in} = 70 \text{ MHz}, f_s = 200 \text{ MHz}, \text{Internal Clock}$

Spurious Pick-up

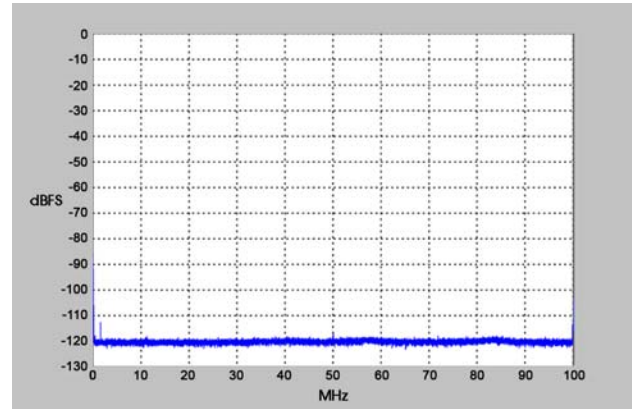

$f_s = 200 \text{ MHz}, \text{Internal Clock}$

Two-Tone SFDR

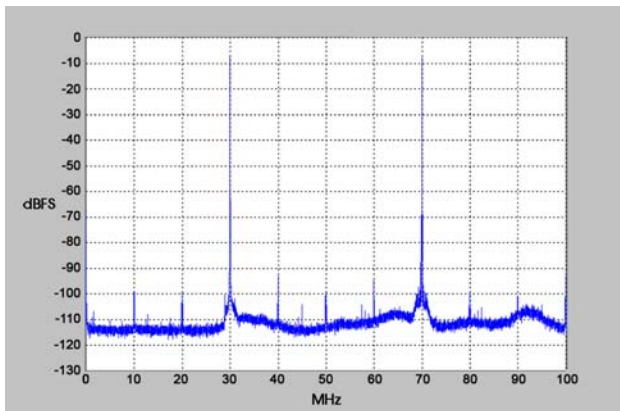

$f_1 = 30 \text{ MHz}, f_2 = 70 \text{ MHz}, f_s = 200 \text{ MHz}$

Two-Tone SFDR

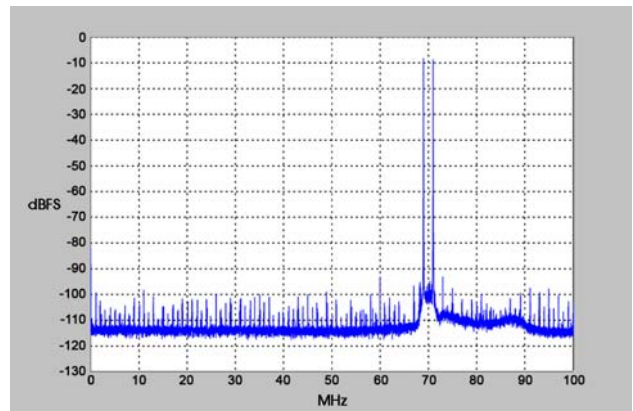

$f_1 = 69 \text{ MHz}, f_2 = 71 \text{ MHz}, f_s = 200 \text{ MHz}$

Adjacent Channel Crosstalk

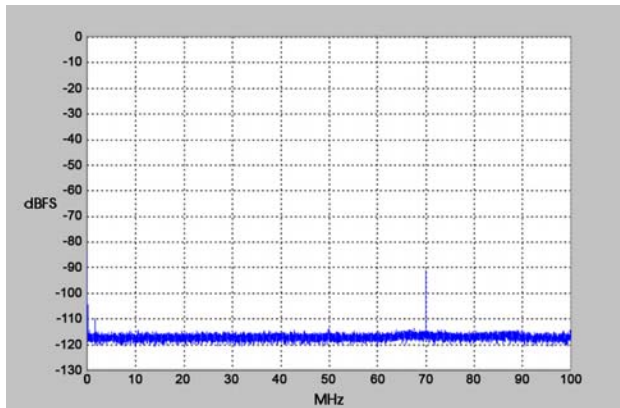

$f_{in \text{ Ch2}} = 70 \text{ MHz}, f_s = 200 \text{ MHz}, \text{Ch 1 shown}$

Input Frequency Response

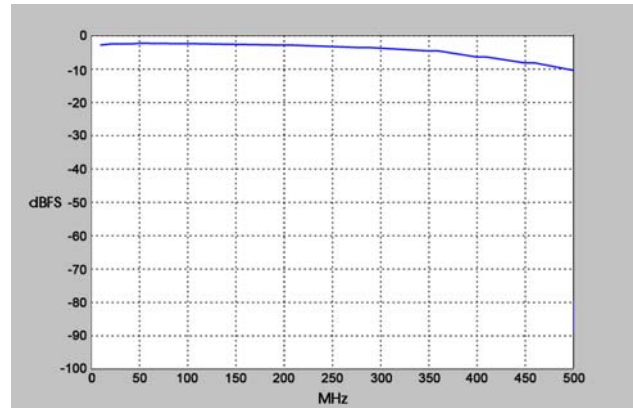

$f_s = 200 \text{ MHz}, \text{Internal Clock}$